

Content List

- 1、 Receiver.....x1
- 2、 Handheld Mic(Bodaypack)
.....x2
- 3、 Audio Cable.....x1
- 4、 Charge Cable.....x1
- 5、 Power Adapter.....x1
- 6、 18500Lithium Battery....x2
- 7、 Manual..... x1

All Right Reserved

UHF Digital Wireless Microphone

KRIEG[®]

K733D

Operating Manual



Please read this manual carefully before use.

CONTENTS

Brief Introduction.....	1
Main Features.....	1
Parts(Receiver).....	2
Receiver Display.....	3
Handheld Mic Operation.....	6
Receiver Operation.....	8
Technique Specification.....	10

1. BRIEF INTRODUCTION

This digital wireless system adopts intelligentized cryptographic hardware. Unique sound and RF performance

With optional professional recharge accessories.
Endurable rechargeable lithium batteries.

Frequencies grouping, colorful TFT LCD and humanized menu make it easy for single or multi-sets mounting.

2. MAIN FEATURES

- Optional UHF band(500-980Mhz)
- Digital audio transmission technology
- Unique digital 16 bit ID pilot technology, no crosstalk disturbance even same frequency.
- Ultra-short audio latency
- 48KHz audio
- Frequency response:30-20KHz
- Colorful TFT display and menu settings
- Auto frequency scanning and spectrum display

7. TECHNIQUE SPECIFICATION

RECEIVER

Carrier Frequency: UHF500-980MHz
Bandwidth: 30MHz
Channel Bandwidth: 300KHz
Preset Group: 15 group, 6 frequencies in each group.
Dynamic Range: 96dB
Distortion: <0.1%
Frequency Response: 30-20KHz/+ -2dB
Signal/Noise Ratio: 96dB
Receiving Sensitivity: -95dBm
Transmission Delay: <3ms
Power Supply: DC12V 1A
Audio Output: 1 x 6.3mm, 1 x XLR balance output

MICROPHONE

Carrier Frequency: UHF500-980MHz
Bandwidth: 30MHz
Frequency Switch: IR SYNC
Output Power: 10mW
Harmonic Radiation: <-50 dBc
Battery: 1x18500 Lithium
Battery life: >8h

8. BODYPACK OPERATION

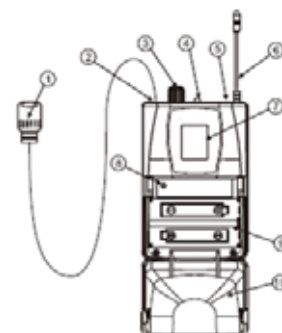

1. MICROPHONE
2. INPUT SOCKET
3. - VOL +
4. ON/MUTE/OFF
5. POWER
6. ANTENNA
7. LCD DISPLAY
8. IR SETTING SWITCH
9. BATTERY SINK: 2X1.5 AA BATTERY
ATTENTION WITH THE RIGHT POLARITY
10. BATTERY COVER

► BODYPACK LCD FUNCTION

-
1. CH Indicates working channel
 2. GR Indicates working group
 3. 07 05 Indicates Group 7, Ch5
 4. 811.50 Indicates current using frequency
 5. Indicates battery status, when flashing indicates battery is low of power
 6. Indicates mute status

- Remove the battery cover, insert 2x1.5AA batteries in correct polarity.
- Pull the switch to "ON" side, if LCD not light, check whether battery in correct polarity or is low of power. If the battery indicator of LCD is flashing, please change with new batteries.
- The bodypack can only work under the same frequency with receiver.
- Automatically enter the default mode when switch on, and automatically save the last used channels, no need to reset if no any change.

Note! The SYNCING period is within 30 seconds.

- Select function by adjusting the SET UP knob (2、 10)
(Function details refer to the Instruction of Receiver TFT LCD display function)
- See below IR SYNC picture, long press IR button under unlock status, Receiver start sending signal, automatically turn to work after completion.

IR SYNC picture

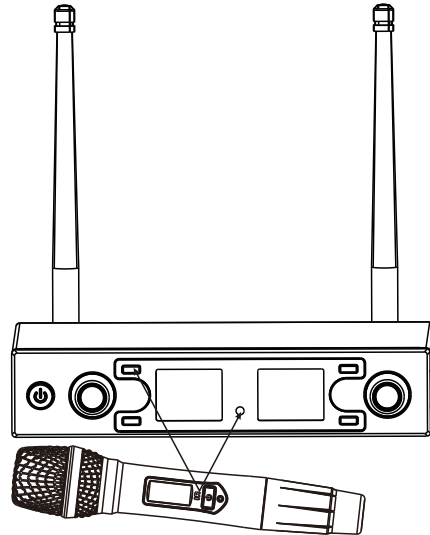

Long press IR button, start sending signal while signal icon flashing, turn on handheld microphone, put the IR window against the Receiver IR window. Signal icon disappear when IR connected, frequency shows the same between handheld microphone and Receiver.

► Warnings of Receiver installation

Beyond 1 meter more away from the wall

Beyond 1 meter more away from the floor

Antenna fully pull out, or will effect receiving signal

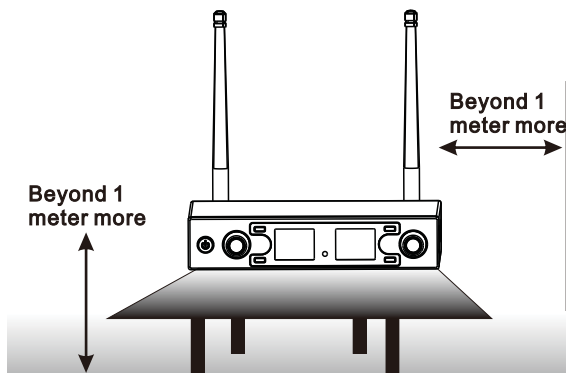

3.PARTS (RECEIVER)

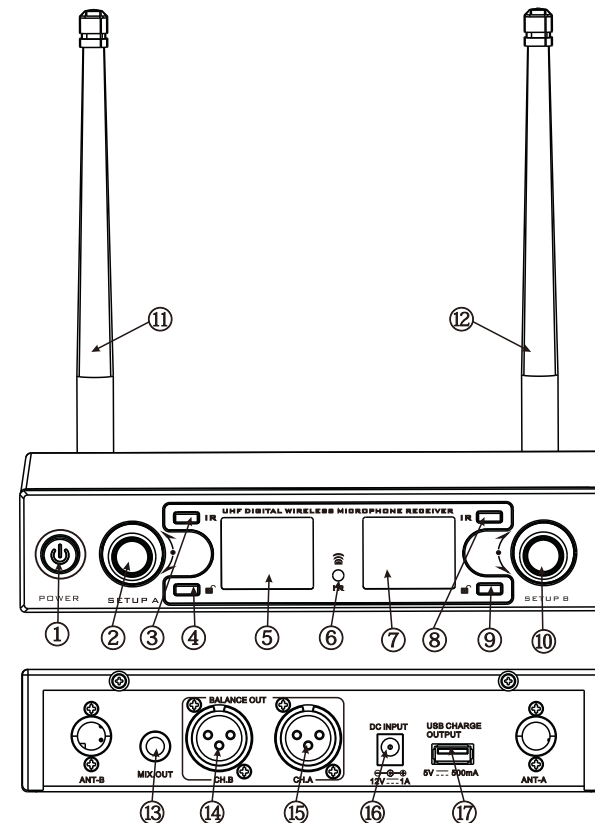

- | | |
|---------------|----------------------|
| 1. POWER | 10. SETUP B |
| 2. SETUP A | 11.ANT-A |
| 3. IR | 12.ANT-B |
| 4. UNLOCK | 13.MIX.OUT |
| 5. TFT WINDOW | 14.BALANCE A |
| 6. IR | 15.BALANCE B |
| 7. TFT WINDOW | 16.DC INPUT |
| 8. IR | 17.USB CHARGE OUTPUT |
| 9. UNLOCK | |

4. RECEIVER DISPLAY

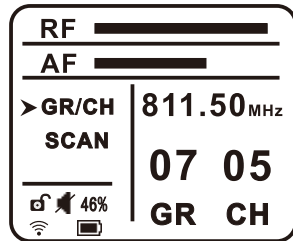

RF  RF: Indicate signal intensity, the longer length of the color, the stronger signal.
AF  AF: Indicate audio level, the longer length of the color, the stronger signal.

GR/CH GR: Group: Digital above the icon indicate the current frequency group.
CH: Channel: Digital above the icon indicate the current group frequency.

SCAN UP DOWN Auto scan. Automatically scan up or down to search for available frequency until the desired frequency is reached. Can be set under SCAN function.

 Lock status, the buttons are inactivated under this status.

 Mute, indicates Receiver is under MUTE status.

46% Indicate the current voice volume of Receiver, adjustable range is 0%-100%

 IR icon, when flashing indicates now is sending SYNC signal.

 Battery icon, indicates the handheld microphone battery status.

(3) Don't put the two microphone to use together:

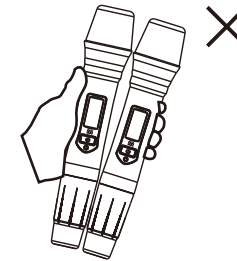

(4) Attention the using distance between the microphone Grille and mouth is less than 15cm.

(5) Avoid pointing the Grille against the Horn.

6. RECEIVER OPERATION

- Pull out the antenna (11), (12), make them to be perpendicular with the receiver.
- Connect the power:
Connect the power cable to the DC socket (16) of the Receiver, make sure the adaptor is suitable before using the Receiver.
- Connect the audio cable:
Mix output: connect the audio cable (attached) to the MIX. OUT socket (13) while the other side connect to MIX. IN or AUX. IN socket of the mixer or amplifier.
Balance output: connect the balance audio cable (purchased additionally) to the BALANCE socket (14/15) while the other side connect to MIX. IN or AUX. IN socket of the mixer or amplifier.
- Connect the USB charge cable:
Connect the charge cable (attached) to the USB socket (17) while the other side connect to the handheld microphone.
- Turn on the power button (1), LCD display (5、7) is lighting, Receiver is in working status. Note: Before turn on the Receiver, turn the volume control knob (2、10) to the minimum volume, adjust the volume as needed when the Receiver is working.



Under working status, long press ON/OFF button until see OFF, then the microphone is off.

- Remove the battery cover, insert 1x18500 Lithium battery in correct polarity.
- Long press ON/OFF button in 3 sec, if LCD not light, check whether battery in correct polarity or battery is low of power. If the battery indicator of LCD display is flashing, please change with new battery.
- The microphone can only work under the same frequency with Receiver.
- Automatically enter the default mode when switch on, and automatically save the last used channels, no need to reset if no any changing done.

Note! The SYNCING period is within 30 seconds.

HANDHELD MICROPHONE USING TECHNIQUE

(1) Don't hold the microphone Grille:

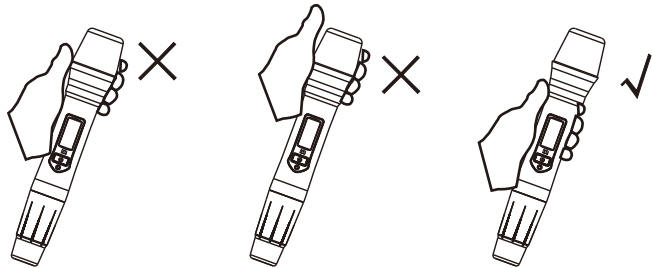

(2) Avoid holding the microphone on antenna position:

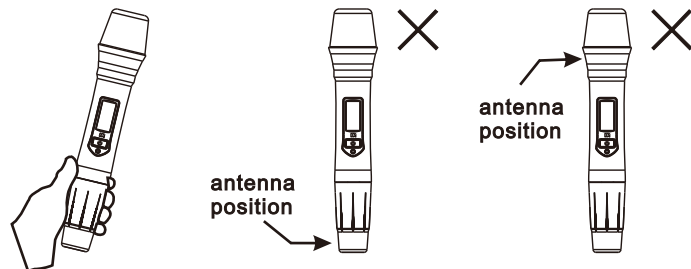

Display function operation

- When the receiver working, long press UNLOCK to un-locked the system before setting. Initial setup from channel adjustment, below is the operation of the product.

Note: the below setting is under unlock status, long press UNLOCK before setting.

- Channel setting model

select menu icons

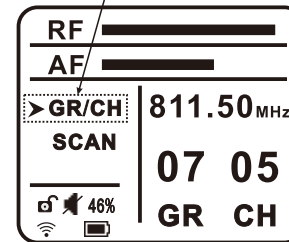

numbers change

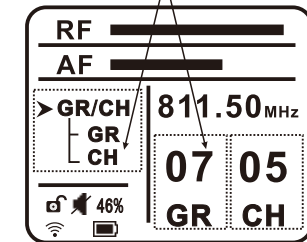

(1)

Adjust SETUP control knob, and press it enter into the channel setting mode while GR/CH is flashing. Then adjust the control knob to select the appropriate menu items, select the appropriate channel by increasing or decreasing. Pressing the control knob to confirm after select the appropriate channel, finally press IR function to syncing. (As shown in Figure 1)

- Scan available channel mode

select menu icons

Spectrum Analysis of Enviromental

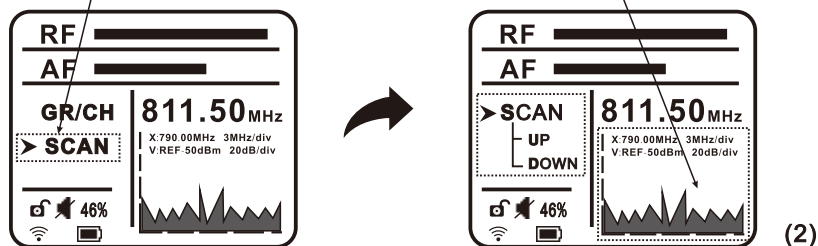

Adjust SETUP control knob, press SCAN function enter into scan available frequency mode. Then adjust the control knob, select UP or DOWN can automatically scan up or down to search for available frequency until the desired frequency is reached (2). This function is convenient for user to find the available frequency quickly under different situation.

- Transmitter power setting

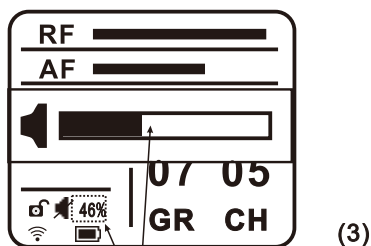

Voice Volume

Adjust SETUP control knob, can directly adjust the Receiver voice volume, obviously showed by Bar chart and numbers.

5. HANDHELD MICROPHONE OPERATION

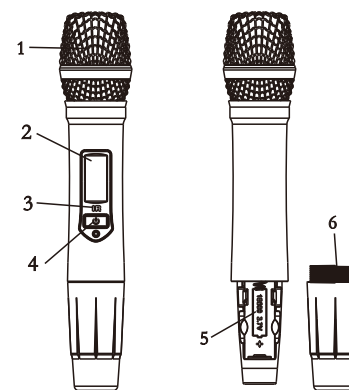

- 1、Microphone capsule: use to pick up sound.
- 2、LCD display: indicates the microphone working information status.
- 3、SYNC window: use to receive IR signal, when SYNCING must put against to the Receiver IR window .
- 4、ON/OFF switch: control the handheld microphone of power on, mute and off.
- 5、Battery Sink: insert 1x18500 lithium battery, note to insert in correct polarity.
- 6、Mic cap: unscrew it when change battery.

► HANDHELD MICROPHONE LCD FUNCTION

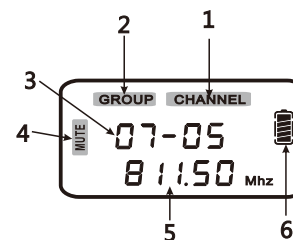

- 1、**CHANNEL** Indicates working channel
- 2、**GROUP** Indicates working group
- 3、**07-05** Indicates Group 7, Ch05
- 4、**MUTE** Indicates mute status
- 5、**811.50 Mhz** Indicates current using frequency
- 6、**[Battery Icon]** Indicates battery status, when flashing indicates battery is low of power